

INFINITY

LOOK SYSTEM



STOSA
CUCINE

STOSA
UNA FAMIGLIA ITALIANA
55 ANNI DI STORIA E UNA SOLA
GRANDE PASSIONE LA CUCINA

Stosa, an italian family. 55 years of history and one great passion: kitchens.

Da 55 anni produciamo solo cucine, create e prodotte per migliorare la vita di chi, ogni giorno, vive nello spazio più conviviale della casa. Progettiamo e realizziamo esclusivamente in Italia prodotti eccellenti nella qualità, realmente sostenibili per ogni famiglia italiana e per i giovani. Ecco perché una cucina Stosa nasce da valori autentici come impegno, onestà, rispetto e originalità. In Italia e in oltre 40 Paesi nel mondo, con un mercato in costante espansione. Impegno per dare il meglio di noi attraverso ogni singola cucina, direttamente a casa tua. Onestà per trasformare i nostri progetti in spazi di vita davvero sostenibili. Rispetto per la natura che ci circonda e per tutta la filiera produttiva. Originalità per essere sempre più competitivi nell'innovazione tecnologica e funzionale. È così che ogni giorno costruiamo le nostre cucine. Pensando a te.

For 55 years we've been producing only kitchens, designed and built for those who enjoy spending time in the most welcoming room in the home. Our products, designed and made entirely in Italy, stand out for their quality yet are affordable for Italian families and young people. Because a Stosa kitchen is based on authentic values like commitment, honesty, respect and originality in Italy and a further 40 countries worldwide, with a constantly growing market. Commitment to offer our best in every single kitchen, directly in your own home. Honesty to turn our designs into truly sustainable living areas. Respect for the nature surrounding us and for the whole production chain. Originality to be more and more competitive with regards technological and practical innovation. That's how we build our kitchens every day. Thinking of you.

INFINITY

LOOK SYSTEM

CONTENUTI
CONTENTS pag.2

MATERIAL KITCHEN pag.4

LIGHT KITCHEN pag.42

ELEGANT KITCHEN pag.64

COLORS KITCHEN pag.74

REFINED KITCHEN pag.88

FINITURE
FINISHES pag.106

SISTEMA APERTURE
OPENING SYSTEM pag.108

ABACO COMPOSIZIONI
EXAMPLES OF COMPOSITIONS pag.112



MATERIAL KITCHEN

Finitura Rovere - Oak finish

Pag — 4



Una cucina sperimentale, in cui i materiali si mixano tra di loro per creare ricette sempre nuove partendo dal gusto autentico del Rovere Naturale. Venature, effetti materici e trasparenze sono solo alcuni degli ingredienti a disposizione.

An experimental kitchen in which materials are mixed to create ever-changing, new recipes starting from the authentic style of natural oak. Wood grain, textured effects and transparencies are just some of the ingredients available.

LIGHT KITCHEN

Finitura Larice - Larch finish

Pag — 42



Il Larice come ingrediente principale di una cucina leggera. Bastano poche altre finiture, colori misurati e qualche elemento giusto per dare forma a composizioni light nelle tonalità, ma forti nello stile e decise nel sapore.

Here, larch is the main ingredient of a light and airy kitchen. Just a few additional finishes, harmonious colour and some of the right elements create light-coloured arrangements that are still going strong in terms of style and taste.

ELEGANT KITCHEN

Finitura Rovere Gessati - Chalk Oak

Pag — 64



Rovere Deserto e Rovere Ice sono due ingredienti perfetti per cucine eleganti, nella forma e nella sostanza. Si possono mescolare tra di loro o utilizzare singolarmente in abbinamento ad altre finiture, ma il gusto non cambia.

Rovere Deserto and Rovere Ice are perfect ingredients for kitchens that are elegant in terms of form and of substance. They can be mixed together, used by themselves or paired with other finishes but their style prevails unaltered.

COLORS KITCHEN

Finiture colorate - Coloured finishes

Pag — 74

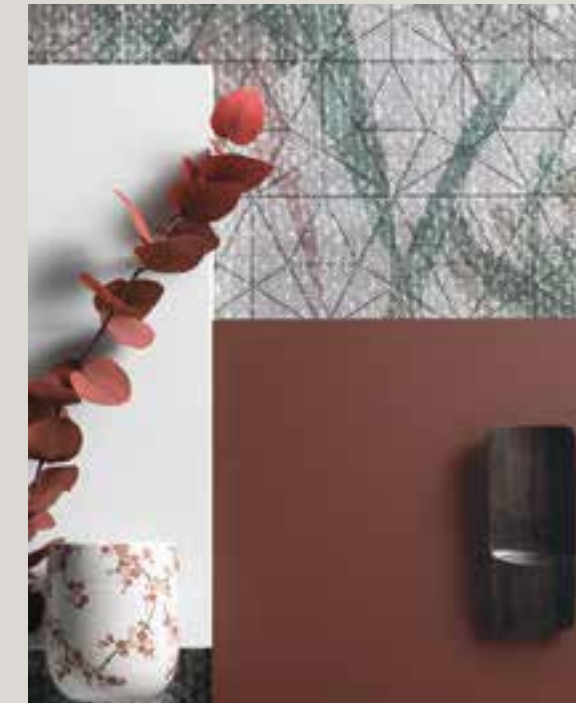

Una cucina fatta di ingredienti colorati e gustosi che insieme creano composizioni belle da vedere, ma anche da utilizzare. Lo stile di cucina ideale per dare un tocco di colore all'ambiente e più sapore alla vita quotidiana.

A kitchen made of colourful, tasteful ingredients that together create arrangements that are at once beautiful to see and use. This is the ideal style of kitchen to add a touch of colour to your home and more tasteful beauty to everyday life.

REFINED KITCHEN

Finitura Palomino - Palomino finish

Pag — 88



Il Palomino è un ingrediente pregiato per i palati più raffinati. Una cucina ricercata, che sceglie accostamenti particolari ed elementi originali che sappiano stupire chi li vede per la prima volta e soddisfare chi li vive tutti i giorni.

Palomino is a prized ingredient for the most demanding of palates. It's a refined kitchen that chooses uncommon combinations and original elements that amaze at a first glance and are satisfying to live with forever after.



MATERIAL KITCHEN

Finitura Rovere / Oak finish

Le venature del Rovere in tutte le sue varianti, la solidità del metallo, la trasparenza del vetro e l'effetto liscio del laccato si incontrano per dare forma a cucine in cui i materiali sono protagonisti. Nell'ambiente dello stare insieme per eccellenza, i contrasti (ma solo quelli materici) fanno tendenza.

Our Oak grain versions, the solidity of metal, the transparency of glass and the smooth effect of lacquer all meet to create kitchens that focus on materials. Contrasting materials (not differences that lead to arguments) set the trend in rooms dedicated to togetherness.

#01

Rovere Natura / Pet Grau lucido - gloss / Fenix Verde Comodoro





COMBO LINE

Un elemento in alluminio e schiene personalizzabili al quale possono essere aggiunti accessori porta calici o porta mestoli. Combo Line è perfetto per attrezzare lo spazio tra i pensili, tra i pensili e le colonne oppure tra le colonne stesse (come nell'immagine). Estetica e funzionalità vanno di pari passo e si traducono in soluzioni utili ma anche di design.

An aluminium unit with customisable shelves and back panels to which utensil hanging accessories can be added. Combo Line is the perfect way to fit out spaces between wall units, between wall and tall units or even between tall units themselves (as shown in the picture). Beauty and functionality go hand-in-hand, offering useful design solutions.





La naturalezza del Rovere rende bella l'estetica della cucina, ma anche la sua funzionalità: i ripiani del divisorio Combo Line, il piano snack dell'isola, i moduli a giorno sempre dell'isola e le colonne multifunzionali. Con il Pet lucido, il Fenix del top e il metallo della struttura del divisorio, la versione più naturale del Rovere si esprime in tutta la sua modernità, grazie all'abbinamento con altri materiali.

The natural beauty of Oak makes this kitchen beautiful as well as functional: the shelves of the Combo Line shelving unit, the island breakfast bar, the island's open shelves and multifunctional tall units. The most natural version of Oak expresses all its modern flair when combined with other materials such as gloss Pet, a Fenix top and the metal of the open shelving unit's structure.



Dalla cucina al living il passo è breve: nella zona giorno si ritrovano le stesse finiture declinate su arredi diversi, ovviamente progettati per funzionalità diverse. La base sospesa diventa piano d'appoggio per la tv ed è in Pet Grau lucido come l'isola della cucina; il pensile in Rovere Natura richiama le colonne della cucina e i ripiani del divisorio Combo Line ma aggiunge moduli a giorno per alleggerire i volumi.

The living room is very close at hand and features the same finishes on different pieces of furniture designed to offer other functions. The wall-hung base units serve to stand the TV unit on and are in gloss Pet Grau, just like the kitchen island; the Rovere Natura wall unit matches the finish of the kitchen tall units and the shelves of the Combo Line open shelving unit but includes open modules to give it a lighter appeal.



#02 Rovere Natura / Cemento Visone / Pet Cachemere opaco - matt





In cucina il gusto è il senso privilegiato, ma anche l'occhio vuole la sua parte: l'anta a due cestoni per lavastoviglie è un dettaglio trompe l'oeil che non interrompe la continuità della gola. Inoltre, gli elementi a giorno Modula valorizzano lo spazio tra la base e i pensili, mentre il cambio di inclinazione del piano snack, oltre a dare una nuova geometria alla cucina, lo trasforma in un comodo tavolo da quattro.

Taste is the main sense used in the kitchen, although sight is also important: the dishwasher door - that mimics two deep drawers - is a detail that lets the decorative horizontal line of the groove continue uninterrupted. Moreover, the Modula open shelving units make the most of the space between the base and tall units while the change in direction of the breakfast bar offers the dual advantage of giving the kitchen new, geometric lines while transforming the surface into a handy table for four.

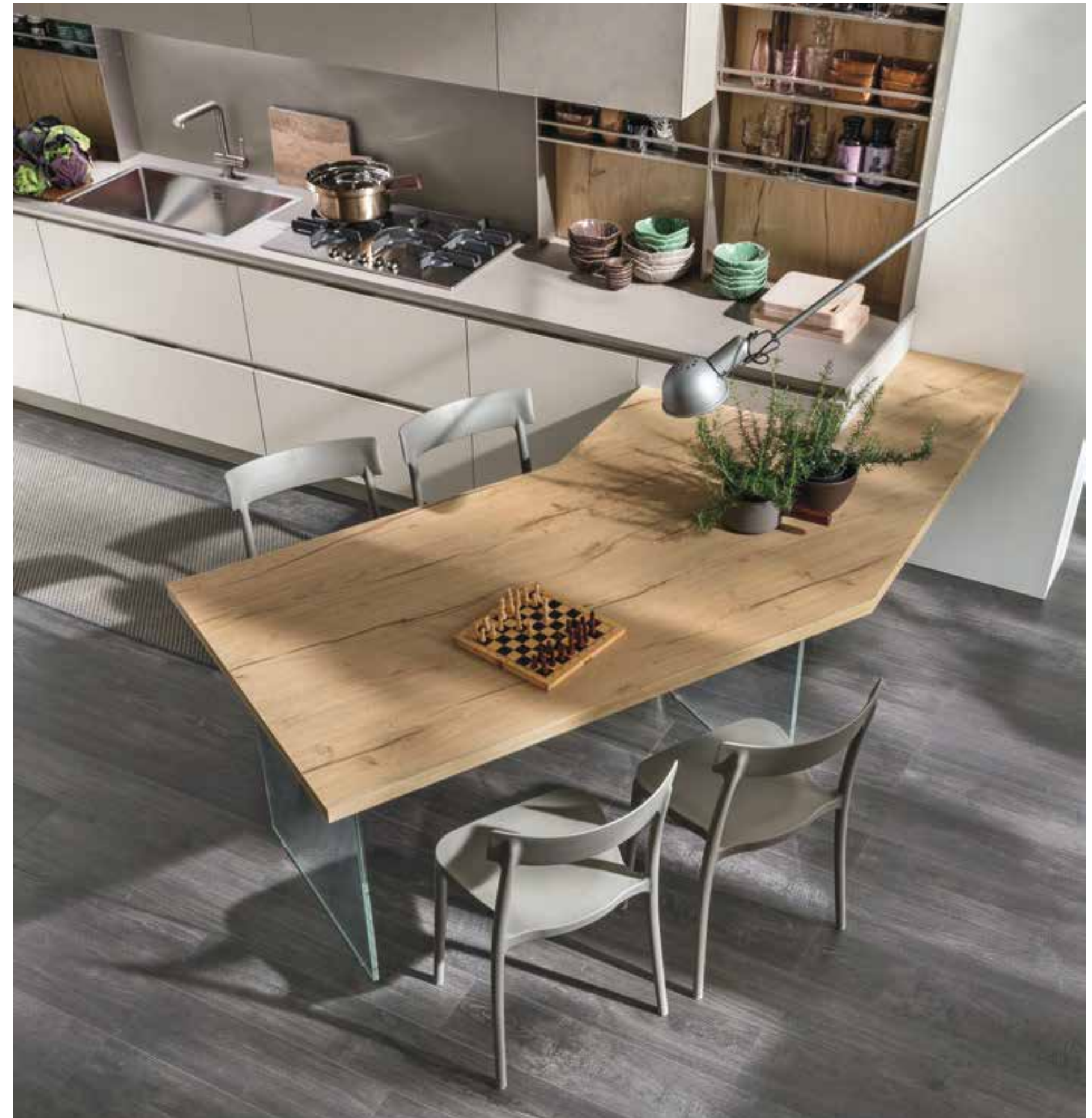

#03

Rovere Natura / Cemento Bianco / Vetro Mattone Bruciato lucido - Gloss Mattone Bruciato glass (Aliant)





Un pratico angolo home office per studiare o lavorare può essere creato anche cucina, non solo nel living: il top in Rovere Natura continua oltre la base, il fianco si appoggia al muro e lo spazio sottostante, oltre a essere utile per contenere un pratico carrello Amico con ruote, è perfetto per aggiungere uno sgabello. Un altro spazio aperto è creato dal modulo a giorno laccato Pomice inserito tra le colonne. Una moderna combinazione di volumi pieni e vuoti.

Although it's more often found in the living room area, a practical home office niche to study or work in can be created in the kitchen too: the Rovere Natura top continues beyond the base units, a side panel stands against the wall and the space below the top becomes perfect to accommodate a stool and a practical, mobile Amico unit on castors. Another open space is created by an open module in Pomice laquered between tall units. A modern combination of solids and voids.





#04

—

Rovere Natura

Pet Bianco Assoluto
opaco - matt

Pet Nero
opaco - matt

—



La cucina si distingue per i contrasti materici e cromatici. La boiserie in Rovere Natura, come la cappa, e la struttura degli elementi Modula in metallo sono abbinati alla finitura liscia Pet. La maniglia scura e lo zoccolo Nero spazzolato risaltano sulle basi bianche, a loro volta accostate alle colonne in Pet nero opaco. La cucina black & white ha un sapore giovane, accentuato nel design dalle colonne a mezza altezza.

This kitchen stands out for its contrasting materials and colours. The Rovere Natura wall panelling - just like the hood and the structure of the metal Modula elements - is paired with a plain Pet finish. The dark-coloured handle and the black, Nero Spazzolato, plinth stand out from the white base units paired with matt Pet Nero midi units. This black & white kitchen has a young appeal, set off by the design of the midi units.





#05

—

Rovere Nodato

Pet Bianco Assoluto
lucido - gloss

Pet Bianco Assoluto
opaco - matt

—





In cucina si fanno notare le geometrie: l'anta a trapezio crea dei tagli diagonali sui pensili, le colonne medie sono visivamente più leggere di quelle a tutta altezza, il top quadrato in legno sporge dalla base e diventa un bancone snack. Il Rovere Nodato e il Pet Bianco, lucido e opaco, sono le uniche finiture di una cucina dal gusto nordico, che esprime naturalezza ma anche modernità grazie all'originalità dei suoi elementi.

Geometric shapes stand out in this kitchen: trapezium-shaped doors create diagonal lines on wall units, midi units are visibly lighter than full-height tall units and the wooden, square-section top protrudes from the base units and becomes a breakfast bar. Rovere Nodato and gloss and matt Pet Bianco are the only finishes chosen for this Scandinavian-style kitchen that has a natural yet modern appeal thanks to the originality of its furniture.





Gli scaffali Amico sono accostati l'uno all'altro per comporre una vera e propria dispensa a vista, nella quale riporre stoviglie, ingredienti, elettrodomestici e tutto quello che non trova spazio sul top della cucina, ma deve essere comunque a portata di mano. La struttura è in finitura Peltro, mentre i ripiani alternano il Rovere Nodato al Pet Bianco opaco e si possono facilmente spostare a seconda delle necessità di spazio o del proprio gusto personale.

Amico open shelving units are fitted side-by-side to compose an open larder that can contain dishware, groceries, appliances and anything else that cannot stand on the kitchen worktop but still needs to be close at hand. The structure has a Peltro finish while the shelves are in alternating Rovere Nodato and matt Pet Bianco and can be easily moved depending on how much space is required and one's own personal taste.



#06

Rovere Nodato

Laccato Peltro opaco
Matt Peltro lacquered



Tanti gli elementi e i dettagli in Rovere: le colonne a tutta altezza con gola piatta in finitura Titanio, la cappa Isola Ipe in lamiera con inserto in Rovere Nodato, il piano della penisola Diagonal con la sua particolare forma irregolare e la gamba in vetro, i ripiani degli scaffali dispensa. Oltre al design, anche le finiture sono protagoniste in cucina e le loro combinazioni sono importanti per esprimere la personalità dell'ambiente, ma soprattutto di chi lo vive.

Oak is used here on lots of units and in many details: on the full-height tall units with Titanio finish flat grooves, on the Ipe island hood with its Rovere Nodato insert, on the Diagonal peninsula top with its original, irregular shape and glass legs and on the shelves of the open shelving unit. Finishes, as well as design, rule in this kitchen and the two work together to express the personality of the home and, more importantly, of those who live in it.



#07

—
Rovere Nodato

Calce
—



La madia appartiene al passato, ma con le sue linee essenziali e il suo carattere multifunzionale, è l'arredo ideale per essere inserito in uno stile moderno dal sapore vintage. La sua finitura materica Calce con elemento a giorno color Verde Bosco si abbina perfettamente al Rovere Nodato delle mensole. È perfetta in cucina per creare un piccolo angolo living dalla grande resa estetica.

Sideboards belong to the past but, with their minimalist lines and multifunctional character, they are still an ideal choice for a vintage-style, modern setting. This one's textured Calce finish with its Verde Bosco open shelving compartment perfectly complements the Rovere Nodato shelves. An ideal choice in the kitchen where it creates a small yet beautiful living room area.





Legno e bianco sono la coppia consolidata dell'arredamento in stile nordico. Nella cucina, questo stile è interpretato con il Rovere e la finitura Pet, ma anche con l'essenzialità delle linee. Non mancano gli elementi originali, come l'anta a due cestoni per lavastoviglie.

Wood and white are a typical pairing in Scandinavian-style furniture. This style is interpreted in the kitchen by using Oak together with a Pet finish as well as by choosing minimalist lines. Original elements, such as the dishwasher door with two deep drawer fronts, are also present.

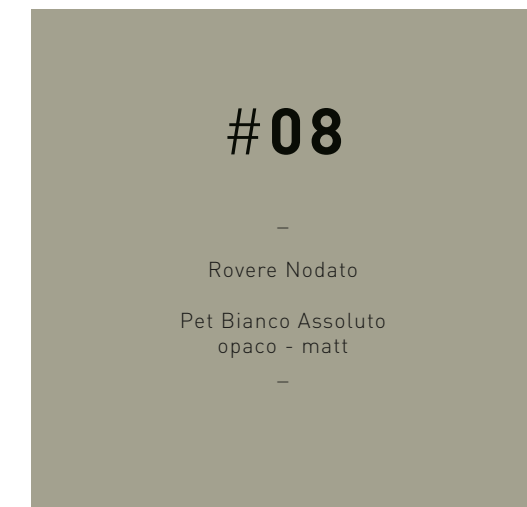



LIGHT KITCHEN

Finitura Larice / Larch finish

Le venature delicate del Larice, in versione bianca o più scura, si abbinano perfettamente ad altre tonalità neutre o a finiture materiche dalle texture delicate.

Il risultato sono cucine che infondono leggerezza a tutti i tipi di spazi e sono perfette soprattutto negli ambienti di dimensioni ridotte.

The delicate grain of Larch in white or darker finishes looks perfect with other neutral shades or with materials featuring a slightly-textured feel.

They result in kitchens that convey lightness to all sorts of spaces and look particularly right in smaller rooms.

#09 Larice Bianco / Pet Cachemere opaco - matt





SCHIENALE MAGNETICO

magnetic back panel

Sullo schienale magnetico si possono attaccare, staccare e spostare a proprio piacimento una serie di oggetti: grazie al porta spezie gli aromi preferiti sono sempre a portata di mano, con il porta tablet si possono guardare e seguire passo passo i video delle ricette. Una soluzione originale e allo stesso tempo pratica per chi vive la cucina tutti i giorni ed è alla ricerca di elementi sempre più funzionali.

All sorts of objects can be attached, removed and moved around as required on the magnetic back panel: your favourite herbs and spices are always close at hand thanks to the spice-rack and you can watch the videos of your recipes and follow them step-by-step thanks to the tablet stand. An original yet practical idea for those who use the kitchen every day and are looking for increasingly more functional elements.





CABINA ANGOLO

corner closet

La cabina ad angolo aggiunge funzioni alla cucina e diventa un comodo ripostiglio all'interno del quale può trovare posto anche la lavatrice. L'anta con telaio nero spazzolato e vetro grigio semi-trasparente racchiude ma non chiude completamente lo spazio: un dettaglio per dare stile alla funzionalità.

The corner closet adds extra functions to the kitchen: it's a handy cupboard that can even house a washing machine. The semi-transparent grey glass door with its Nero Spazzolato frame marks off the space without completely isolating it; a detail that adds style to functionality.





In cucina è interessante anche soffermarsi sui dettagli. La base ha una particolare apertura con finta gola, in cui la gola è direttamente integrata nell'anta. Quando l'anta si apre svela due pratici cassetti interni ideali per riporre stoviglie e biancheria da tavola. Sopra lo schienale magnetico, i moduli a giorno Size hanno gli interni in Larice Bianco per richiamare la finitura di basi e pensili.

It's always interesting to take a close look at the details of a kitchen. The base unit has an original opening method similar to a handle-less channel in which a recess is incorporated in the door. On opening, the door reveals two, practical interior drawers in which dishware and table linen can be stored. The Size open shelving modules have Larice Bianco interiors that pick up the finish of the base and wall units.



#10

Larice Grafite

Pet Grigio Nebbia
opaco - matt



La cucina in finitura Pet con gola a contrasto, ritrova naturalezza grazie alle colonne in Larice. Le stesse venature caratterizzano anche la schiena degli elementi a giorno Modula che attrezzano lo spazio tra i pensili e le colonne. La composizione è lineare e punta molto sui volumi, ma senza trascurare lo stile e un abbinamento di finiture molto di tendenza.

A natural touch is afforded to this Pet-finish kitchen with contrasting grooves thanks to the larch tall units. The back panel of Modula open shelving units that furnish the space between wall and tall units feature the same grain. This is a linear arrangement that focuses mainly on volumes without forsaking style and a very trendy combination of finishes.



#11

Larice Bianco / Cemento / Fenix Verde Comodoro / Pet Grigio Fumo opaco - matt





Il Larice Bianco evidenzia alcune parti della cucina e viene utilizzato per creare un legame visivo e materico tra gli elementi: la cappa, i pensili, la schiena dei moduli a giorno Size e il tavolo. Le tonalità chiare sono predominanti, ma i dettagli, come le maniglie, lo zoccolo, la struttura dei moduli Size e le sedie, aggiungono delle note di contrasto. La gamba in vetro del tavolo dà ulteriore leggerezza.

Larice Bianco sets off some parts of this kitchen and is used to create a visual and material link between the hood, the wall units, the back panel of Size open shelving modules and the table. Light-coloured shades prevail but some of the details, such as the handles, the plinth, the structure of Size modules and the chairs, add contrasting notes. The glass leg of the table adds an even lighter appeal.



Colorate per valorizzare una parete oppure con una finitura Cemento per ottenere un effetto materico moderno: le colonne mantengono sempre la loro funzione primaria di contenimento, ma a seconda dei gusti possono diventare un mezzo per esprimere un determinato stile. In entrambe le versioni, la maniglia integrata nera è in tinta con lo zoccolo.

Coloured to make the most of a wall or with a Cement finish for a modern, textured effect: tall units preserve their main storage function but – depending on individual tastes – can also become a way of expressing a specific style. In both versions the black integrated handle matches the colour of the plint.

#12

—
Larice BiancoCemento
—



ELEGANT KITCHEN

Finitura Rovere Gessati / Chalk Oak finish

Il Rovere assume due tonalità diverse che stanno bene insieme o anche abbinato ad altre finiture neutre o colorate. In tutti i casi, le cucine hanno un aspetto elegante: anche quando c'è un tocco di colore sugli arredi o sulle pareti, il Rovere ha il potere di rendere la composizione sobria nel suo insieme.

Oak takes on two different shades that look beautiful together or paired with other neutral or coloured finishes.

No matter the finish of the kitchen, elegance is always the result: even when colour accents decorate the furniture or the walls, Oak is capable of infusing the arrangement with a subtle overall charm.





Due varianti di Rovere, Ice più chiaro e Deserto più naturale, sono le finiture principali di una cucina dalle dimensioni generose ma dai toni delicati. Il top scuro in marmo dà un tocco di eleganza mantenendo la naturalezza d'insieme, mentre le maniglie applicate disegnano una particolare e sottile linea ondulata sulle ante delle basi e delle colonne. I dettagli in Peltro, come la cappa, lo zoccolo e le maniglie, aggiungono modernità.

Two Oak versions – lighter Rovere Ice and more natural Rovere Deserto – are the main finishes of a generously-sized kitchen featuring gentle shades. The dark marble worktop adds a touch of elegance while preserving the overall natural tone while the handles draw an original, slim and wavy line on the doors of base and tall units. Peltro details, such as the hood, the plinth and the handles, add a touch of modernity.

#14

—
Rovere DesertoPet Bianco Assoluto
opaco - mattOcra
nobilitato - melamine
—



Il fianco a giorno della base e della colonna sceglie una tonalità accesa per aprire la cucina al colore, ma anche alla zona living. Un elemento d'arredo perfetto per mettere in comunicazione due ambienti diversi per funzionalità che però si trovano a condividere lo stesso spazio. I moduli a giorno color Ocra sono pratici e allo stesso tempo molto decorativi se valorizzati da libri e complementi.

The open end elements on base and tall units choose a bright shade that adds colour to the kitchen but also opens the way to the living room area. This element is perfect to link two areas that have different functions while sharing the same space. When used to showcase books and accessories, these Ocra colored open modules are practical yet very decorative.



COLORS KITCHEN

Finiture colorate / Coloured finishes

La forza del colore si esprime nelle cucine moderne. I colori possono essere inseriti a piccole dosi, possono essere abbinati a finiture chiare o neutre oppure possono essere mixati ad altri colori per ottenere composizioni creative. In tutti i casi, il colore si fa notare e trasmette sensazioni positive.

The power of colour expresses itself in modern kitchens. Colours can be added here and there and paired with light-coloured or neutral finishes or mixed with other shades to achieve creative arrangements. In any case, colour gets itself noticed and transmits positive sensations.

#15

Cemento Visone / Fenix Verde Comodoro / Pet Bianco Assoluto opaco - matt / Fenix Beige Arizona





La cucina ha tutte le caratteristiche di un ambiente dinamico: il tavolo pentagonale collegato alla penisola, le maniglie nere dalla geometria originale, i pensili colorati, la cappa in vetro e le colonne in tre diverse finiture. Il colore trova una perfetta compagnia nel Pet bianco delle basi e nel top Cemento Visone.

The kitchen embodies all the characteristics of a dynamic room: the pentagonal table connected to the peninsula units, the original-shaped black handles, the colourful wall units, the glass cooker hood and the tall units in various finishes. Colour finds perfect companions in the Pet Bianco base units and in the Cemento Visone worktop.





#16

Pet Bianco Assoluto
opaco - matt

Fenix Grigio Efeso

Verde Bosco, Arancio, Ocra
nobilitato - melamine



Una cucina giovane e creativa che si prolunga verso il living, un open space aperto alla vita in famiglia e con gli amici. Gli elementi d'arredo, le forme e i colori: qui tutto è libero dagli schemi e allo stesso tempo tutto è studiato in ogni minimo dettaglio per creare un ambiente vivace ma equilibrato. La cucina-living è multicolor ma anche multitasking.

A young and creative kitchen that extends into the living room, an open space perfect for family and social life. Furniture, shapes and colours: everything here breaks out of the mould and has been painstakingly designed in every detail to create a lively yet balanced setting. This kitchen-living room is multicoloured and multitasking.

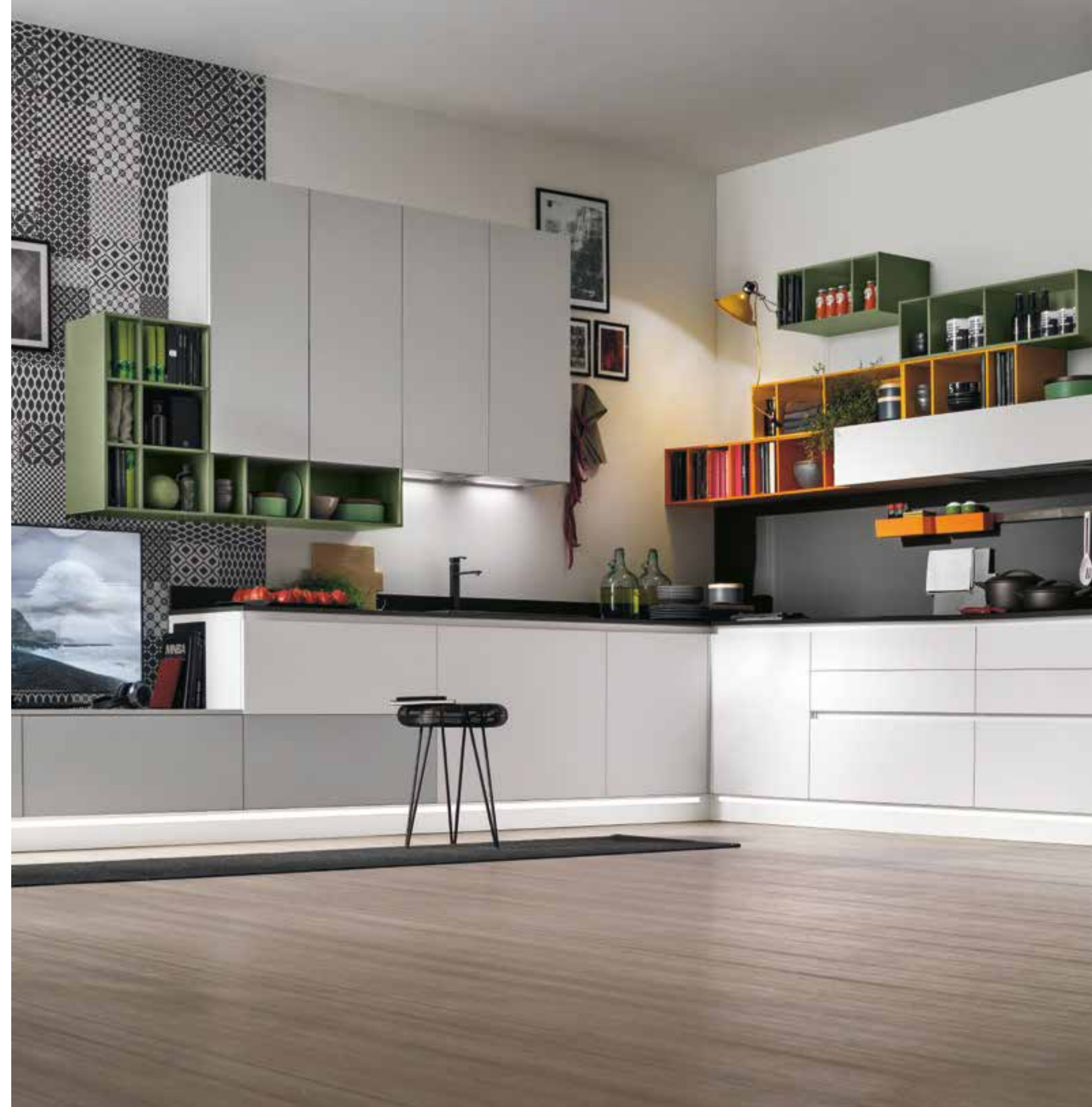



TAVOLO ESTRAIBILE

pullout table

La base a due cestoni è una pratica soluzione salvaspazio che contiene un tavolo estraibile: solo quando viene aperto diventa una comoda penisola, che va ad aggiungere spazio utile al piano pentagonale. Con pochi e semplici step la cucina cambia aspetto in tempo reale, a seconda delle esigenze. Lo spazio aumenta, ma quando non serve più il tavolo estraibile torna al suo posto.

The base unit with two deep drawers is a practical, space-saving idea that contains a pullout table: when it is open it becomes a handy peninsula that adds useful space to the pentagonal top. Thanks to a few, simple steps the kitchen takes on a different appearance in real time to meet changing requirements. Space is extended but the table goes back in place again when it is no longer needed.



#17

—
Cemento

Fenix Grigio Bromo

Fenix Verde Comodoro



Dal punto di vista estetico, la finitura Cemento di basi e colonne dà alla cucina un carattere metropolitano, accentuato dalle tonalità dei pensili. Dal punto di vista funzionale, il pensile-cappa ha una diversa profondità rispetto agli altri pensili: la cappa è inglobata all'interno di un elemento che si distingue dagli altri per la maggiore profondità e anche per colore, creando un particolare effetto dinamico.

From an aesthetic viewpoint, the Cement finish of the base and tall units gives the kitchen a metropolitan appeal, set off by the colour of the wall units. Looking at functionality, the hood wall unit is deeper than the other wall units: the hood is integrated inside an element that stands out from the others because of its depths and colour, creating a special, dynamic effect.



REFINED KITCHEN

Finiture Palomino / Palomino finishes

Nelle varianti Noce o Bianco, la finitura Palomino porta con sé una naturale raffinatezza, che può essere declinata anche sui complementi d'arredo, come tavoli o madie. L'effetto d'insieme non è mai eccessivo, ma sempre ricercato, anche quando il Palomino viene abbinato a dettagli colorati o finiture materiche.

In the Noce or Bianco versions, the Palomino finish has a natural refinement to it that can even be used to finish furniture such as tables or sideboards that does not fall under the category of a kitchen cabinet. The overall effect is never overbearing but always subtle, even when Palomino is paired with coloured details or textured finishes.



#18

—
Palomino NocePet Bianco Assoluto
lucido - gloss

—



Il pensile-cappa ha un'originale forma a trapezio: l'apertura a ribalta svela un pratico spazio per contenere, ma anche la cappa nascosta all'interno del pensile. Una volta chiuso, si notano i tagli diagonali dell'anta che caratterizzano il pensile e aggiungono una particolare geometria alla cucina. La doppia finitura è l'ideale per dare movimento alla composizione dai volumi importanti.

The hood wall unit has an original trapezium shape: the lift-up door reveals a practical storage compartment as well as the hood concealed inside the unit. Once shut, the diagonal lines of the door become visible and distinguish the wall unit, adding an original, geometric line to the kitchen. The two finishes used are ideal to add movement to the impressive volumes of this arrangement.





I complementi completano l'arredamento della cucina e riprendono le linee diagonali già viste in cucina, ma anche la stessa finitura in Palomino Noce delle basi e delle colonne. Il tavolo, le panche e la madia hanno basamenti diversi, ma tutti con gambe inclinate. Nella zona pranzo, le panche sostituiscono le classiche sedie con uno stile più ricercato; nel living, la madia introduce con discrezione lo stile della cucina.

Complementary items complete the kitchen furnishings and pick up the diagonal lines of the cabinets as well as the Palomino Noce finish of the base and tall units. The table, benches and sideboard have different bases, all with a slanting finish. For the dining area, the benches replace the typical chairs with their more refined style. In the living area, the sideboard discreetly extends the style of the kitchen.



La modernità della presa gola, i dettagli di design come i moduli a giorno e gli arredi funzionali come le colonne incontrano particolari di ispirazione vintage: la base con angolo cottura ha un basamento ispirato agli anni Settanta. Un dettaglio stilistico dal sapore vintage per una cucina al passo con i tempi.

The modern appeal of the groove, design details such as open shelving modules and functional furniture such as tall units meet details inspired by the vintage style: the legs of the base unit with hob are reminiscent of the 70s. A stylistic detail with a vintage flavour to it for a kitchen abreast of the times.

#19

—
Palomino Noce
Cemento Calce
Fenix Grigio Londra
—





#20

—
Palomino Bianco

Cemento Visone

Vetro Salvia lucido (Aliant)
Gloss Salvia glass (Aliant)



Oltre alle finiture, anche la scelta degli elementi e dei dettagli contribuisce a rendere ricercata la cucina: il pensile maxi, caratterizzato da un'anta unica modello Aliant in vetro colorato lucido; il top Cemento che riveste anche i fianchi delle basi; la gola e lo zoccolo in finitura Titanio; gli interni dei cestoni illuminati; i moduli a giorno Modula che creano un trait d'union tra i pensili e le colonne.

As well as the finishes, even the choice of the various elements and details contributes to the class of this kitchen: the maxi wall unit featuring a single Aliant model door in gloss coloured glass; the Cemento worktop that extends to cover the sides of base units; the Titanio finish groove and plinth; the insides of illuminated deep drawers and Modula open shelving units that connect the wall and tall units.



Una cucina dai volumi importanti interpretati in maniera diversa dalle finiture: Palomino Bianco per alleggerire visivamente basi e pensili, Cemento Vulcano per caratterizzare le colonne. Tanti gli spazi pieni e chiusi rispetto a quelli vuoti e aperti, ma la composizione sa essere ugualmente delicata.

A kitchen featuring large units that are interpreted in different ways by the finishes: Palomino Bianco makes base and wall units look lighter, Cemento Vulcano sets off the tall units. This arrangement manages to look delicate regardless of the fact that there are many more solids than voids.

#21

—
Palomino Bianco
Cemento Vulcano
—



La cucina è legata e collegata al living attraverso una base porta tv nella stessa finitura Palomino Bianco, che crea continuità e inserisce un'altra funzione nell'open space.

In cucina i pensili alti consentono maggiore capienza, slanciano la composizione verso l'alto e, affiancati da elementi a giorno in metallo laccato Lava, aggiungono anche stile.

The kitchen is visually connected to the living room area by means of a TV base unit in the same Palomino Bianco finish that creates a sense of cohesion while adding an extra function to this open space. In this arrangement, tall wall units offer more storage space while giving the layout a slender, upward soaring appearance which is even more stylish thanks to the addition of Lava lacquered metal open shelving units.



TERMO STRUTTURATO / THERMO STRUCTURED



ROVERE NATURA



ROVERE NODATO

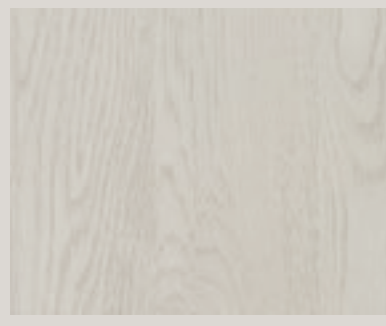

ROVERE DESERTO



ROVERE ICE



LARICE BIANCO



LARICE GRAFITE

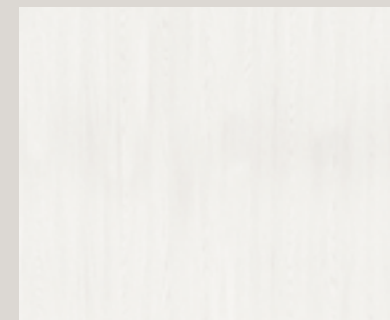

PALOMINO BIANCO

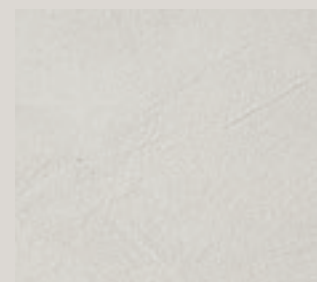

PALOMINO NOCE

LAMINATO MATERICO / TEXTURED LAMINATE

CALCE

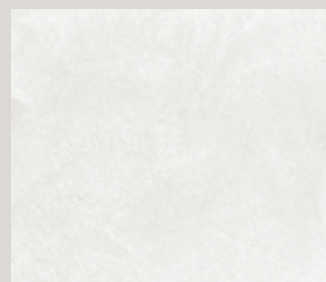

CEMENTO BIANCO

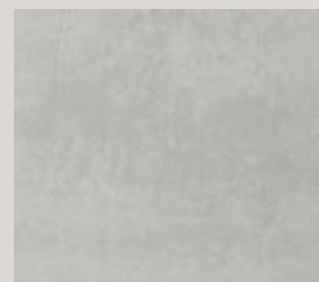

CEMENTO

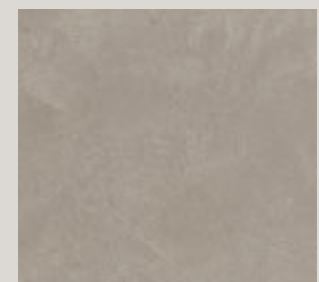

CEMENTO VISONE

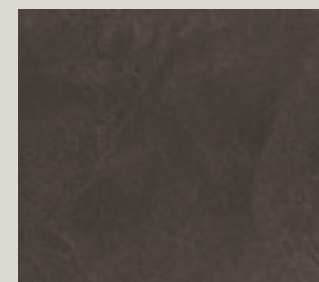

CEMENTO VULCANO

FENIX®

GRIGIO LONDRA

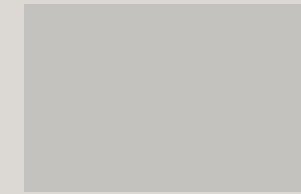

GRIGIO EFESO

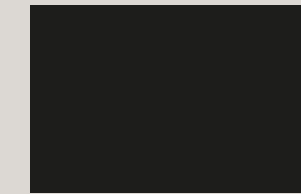

NERO INGO



GRIGIO BROMO

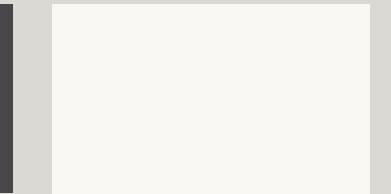

BIANCO KOS



GRIGIO ANTRIM

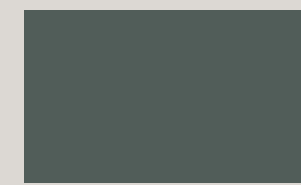

VERDE COMODORO

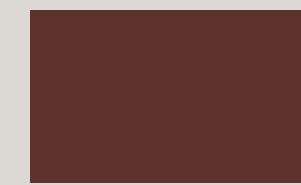

ROSSO JAIPUR

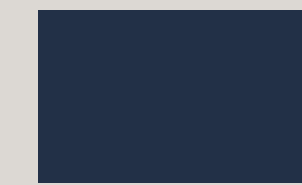

BLU FES

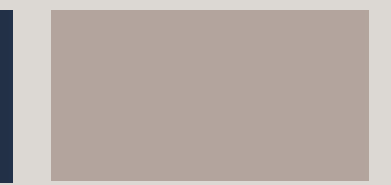

BEIGE ARIZONA

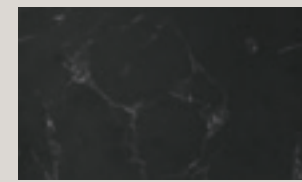

SPACE BLACK

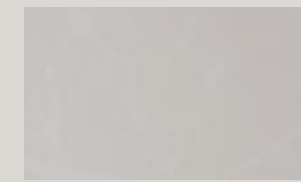

SPACE WHITE

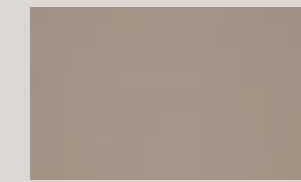

CASTORO OTTAWA

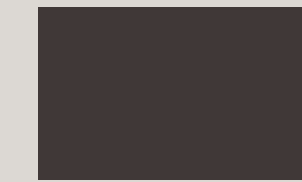

CACAO ORINOCO

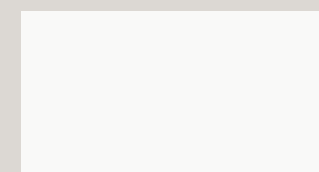
PET LUCIDO E OPACO / GLOSS AND MATT PET

BIANCO ASSOLUTO



GRIGIO FREDDO

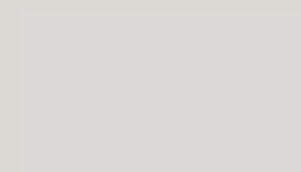

NEBBIA*

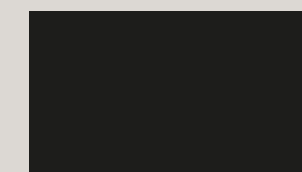

NERO*

* Disponibile solo opaco
* Available only matt

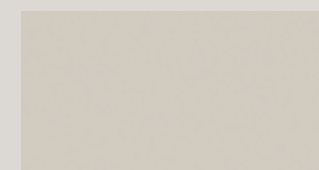

CACHEMERE

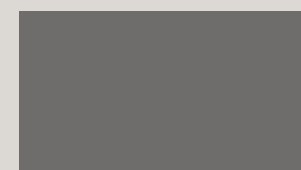

GRAU



GRIGIO FUMO*

SISTEMA APERTURE INFINITY

opening system

Scegliere l'apertura giusta è importante per rendere la cucina adatta alle proprie esigenze o abitudini, ma anche per personalizzarla con un dettaglio di stile. Oltre alle diverse tipologie di gola, sono disponibili per il modello Infinity anche una serie di maniglie, applicate o integrate all'anta.

It's important to choose the right opening method to adapt the kitchen to one's own needs or habits and also to customise it with a stylish detail. As well as various types of grooves, a set of handles is available, either attached to the door or recessed into it.

MANIGLIE HANDLES



Balance

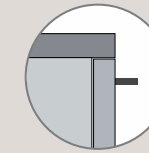

Brooklyn

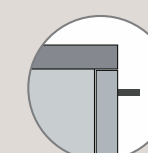

Blade

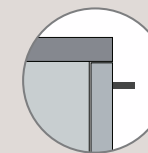

Infinity propone una collezione di maniglie molto semplici ed essenziali, in grado di conferire alla cucina uno stile pulito e minimale.

Infinity offers a collection of simple, minimalist handles capable of giving the kitchen a clean-cut, streamlined style.



Grip
Disponibile da ottobre 2019
Available from October 2019



Incasso

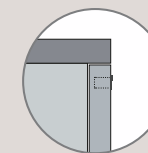

GOLA PIATTA FLAT GROOVE



GP

Gola piatta con tasca
Flat groove with pocket

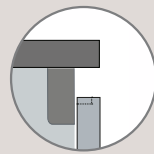

colori _ colors

- NERO SPAZZOLATO
- TITANIO
- BRILL
- BIANCO
- PIOMBO
- PELTRO



GPD

Gola maniglia "Diagonal" per gola piatta
"Diagonal" handle grip for flat groove



colori _ colors

- TITANIO
- BIANCO
- NERO OPACO



GPL

Gola con presa maniglia "L" per gola piatta
Flat "L" handle grip for flat groove

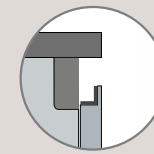

colori _ colors

- TITANIO
- NERO OPACO



La gola piatta è disponibile anche nella versione con fianco di scocca senza la sagomatura della gola.

The flat groove is also available paired with a straight carcass side panel without a groove.

GOLA SCAVATA HOLLOW GROOVE



GS

Gola scavata
Hollow groove



colori _ colors

- NERO SPAZZOLATO
- TITANIO
- BRILL
- BIANCO
- PIOMBO
- FANGO
- POMICE
- ARANCIO
- SENAPE
- OLIVA
- ROSSO VIVO
- ACQUAMARINA



GSD

Gola maniglia "Diagonal" "Diagonal" handle grip

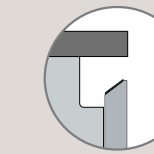

colori _ colors

- TITANIO
- BIANCO
- NERO OPACO



GSL

Presa maniglia "L" "L" handle grip for flat groove

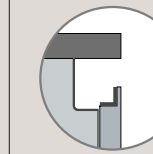

colori _ colors

- TITANIO
- NERO OPACO



La gola scavata è disponibile anche nella versione con fianco di scocca senza la sagomatura della gola.

The hollow groove is also available paired with a straight carcass side panel without a groove.

INFINITY

abaco composizioni / examples of compositions

La caratteristica principale di Infinity è nel nome stesso: la possibilità di creare un'infinità di composizioni per realizzare la cucina dei desideri. In questa selezione, Stosa propone alcune combinazioni di arredi, elementi e finiture che possono essere personalizzate in base alle esigenze di spazio e allo stile di arredamento della casa. Tra tante soluzioni, scegli o crea quella perfetta per te.

Infinity's main quality is contained in its name: it can be used to make an infinite number of arrangements, creating the kitchen of your dreams. In this selection, Stosa offers some combinations of cabinets, furniture and finishes that can be customised to suit the space requirements and interior décor style of any home. Choose or create your perfect arrangement from the many available.

#01 /pag.6

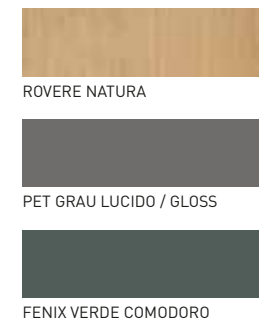
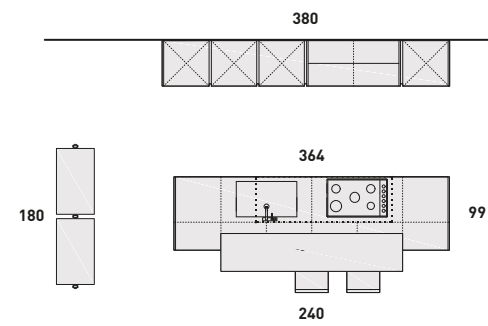

#03 /pag.18

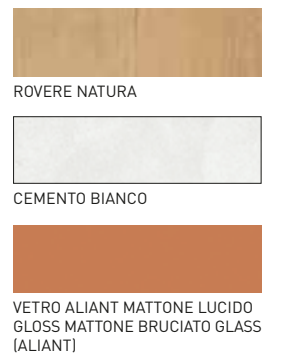
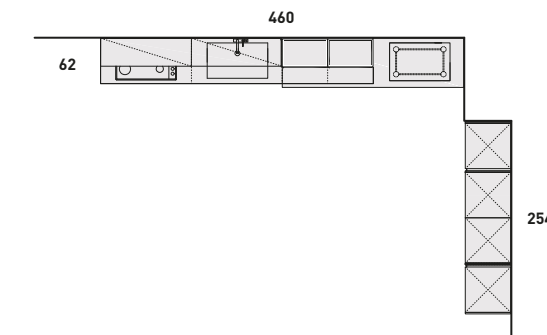

#02 /pag.14

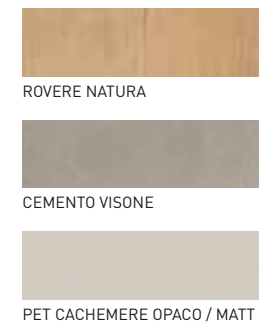
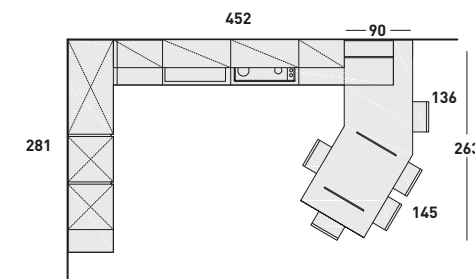

#04 /pag.22

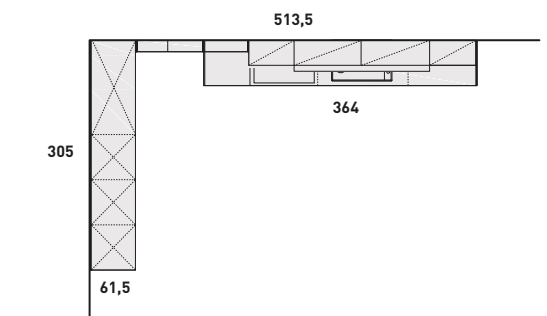

#05 /pag.26

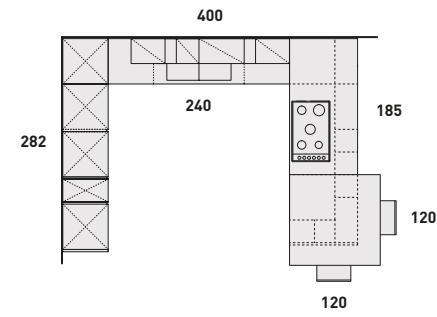

ROVERE NODATO

PET BIANCO ASSOLUTO OPACO / MATT

PET BIANCO ASSOLUTO LUCIDO / GLOSS

#08 /pag.40

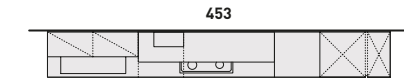

ROVERE NODATO

PET BIANCO ASSOLUTO OPACO / MATT

#06 /pag.32

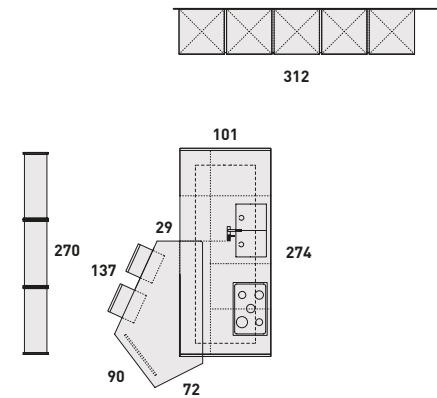

ROVERE NODATO

LACCATO PELTRO OPACO / MATT

#09 /pag.44

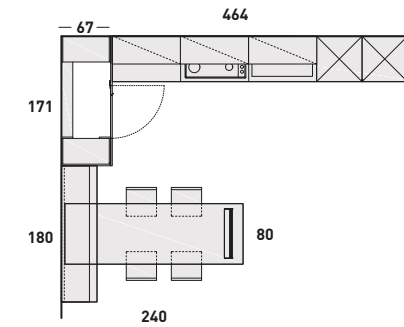

LARICE BIANCO

PET CACHEMERE OPACO / MATT

#07 /pag.36

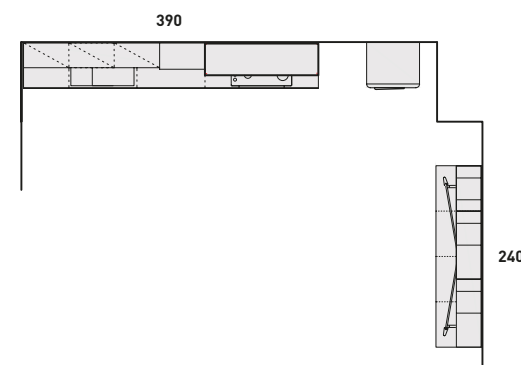

ROVERE NODATO

CALCE

#10 /pag.52

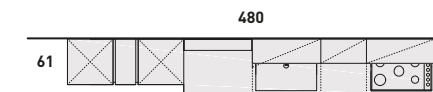

LARICE GRAFITE

PET GRIGIO NEBBIA OPACO / MATT

#11 /pag.56

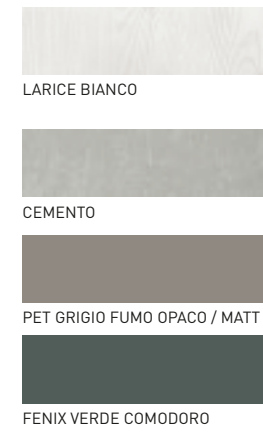
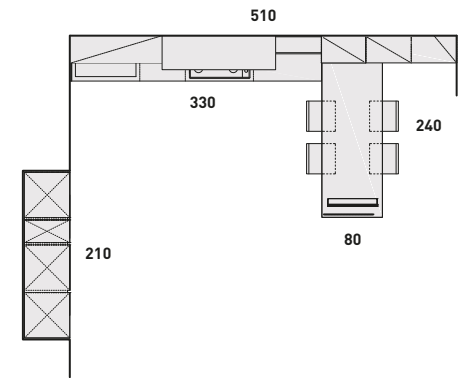

#12 /pag.62

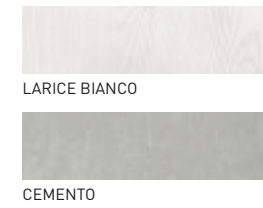
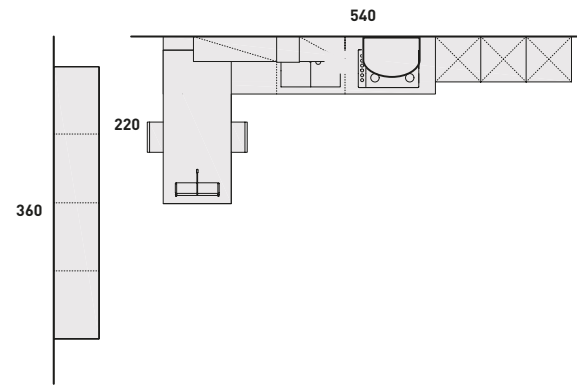

#13 /pag.64

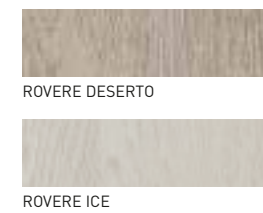
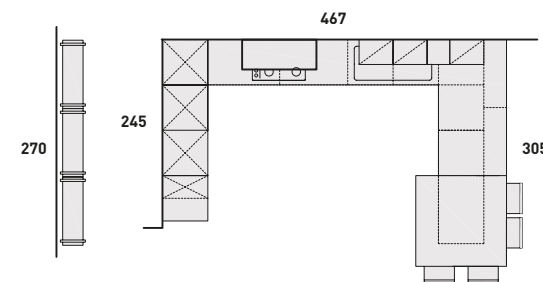

#14 /pag.70

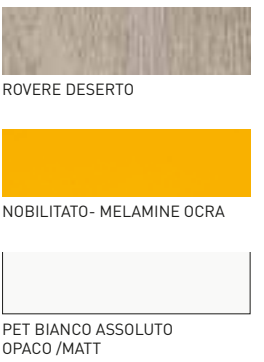
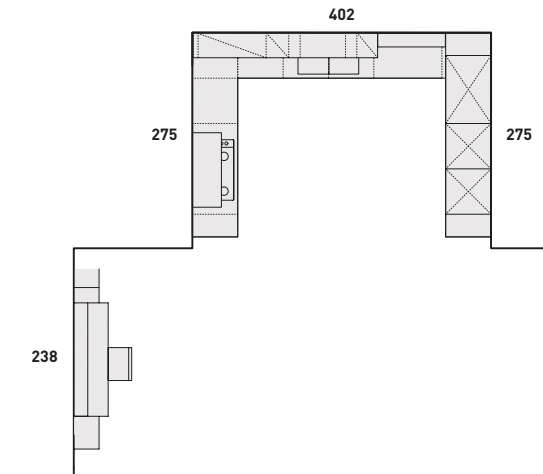

#15 /pag.74

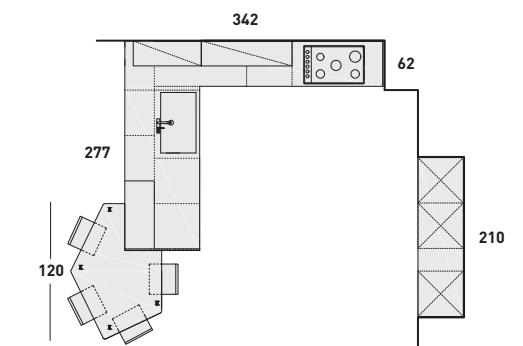

#16 /pag.80

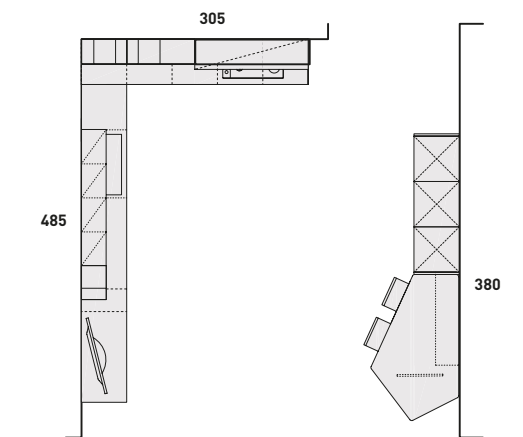

#17 /pag.86

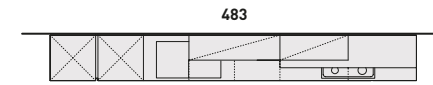

- CEMENTO
- FENIX GRIGIO BROMO
- FENIX VERDE COMODORO

#20 /pag.98

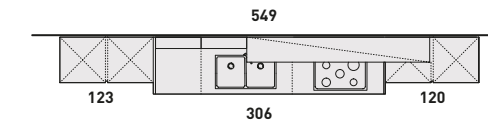

- PALOMINO BIANCO
- CEMENTO VISONE
- VETRO SALVIA LUCIDO
GLOSS SALVA GLASS
(ALIANI)

#18 /pag.90

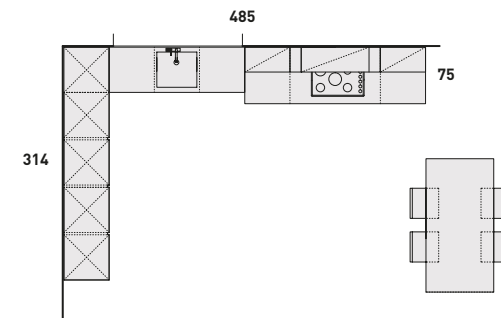

- PALOMINO NOCE
- PET BIANCO ASSOLUTO
LUCIDO / GLOSS

#21 /pag.102

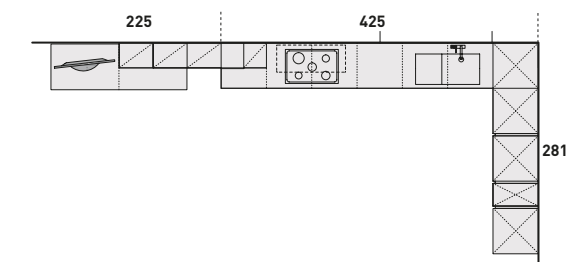

- PALOMINO BIANCO
- CEMENTO VULCANO

#19 /pag.96

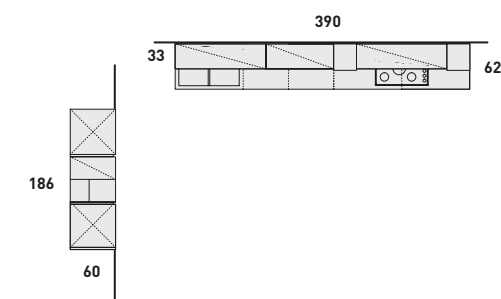

- PALOMINO NOCE
- CALCE
- FENIX GRIGIO LONDRA



product design
ROSSI & CO.
art direction and styling
ROSSI & CO.
graphic design
ROSSI & CO.
photography
STUDIO INDOOR
colour separation
Z13
printed by
PAZZINI STAMPATORE EDITORE



STOSA SPA

S.R.2 Cassia, Km. 149,5
53040 Radicofani (SI) Italy
T. +39 0578 5711
F. +39 0578 50088
stosa@stosa.it

www.stosa.it

